



www.hylineoffroad.com

1507 C West Park Avenue ~ Perkasio, PA 18944
 Tel: 1.888.495.4631 ~ Fax: 215.257.4364

Proudly Made In USA



Installation Instructions:

JK Standard & Crawler Front Bumper
 Part Number(s): **400.100.110 & 400.110.120**

Vehicle Fitment:

2007 - Present Jeep Wrangler
 & Unlimited

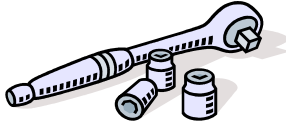
Parts List	
Qty:	
1	Standard Front Bumper
1	Winch Plate
2	Left & Right Bumper Mounting Brackets
1	2012 & Newer Bracket
8	8-32 Lock Nuts
8	8-32 Flat Washers
6	7/16-20 Grade 8 Bolts
14	7/16" Lock Washers
18	7/16" Flat Washers
12	7/16-20 Grade 8 Nuts
2	7/16-20 Weldnut Tabs

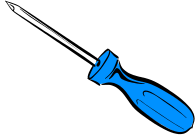
Tools Needed		
		
Ratchet 18mm Deep Socket 6" Extention 11/16" Deep Socket 5/8" Socket 11/32" Deep Socket Torque Wrench	5/8" Wrench	Phillips Screwdriver

Congratulations on your purchase of the Hyline Offroad Standard Front Bumper. Our Bumpers are completely manufactured in our facility located in Perkasio, PA. They are designed and engineered by Offroad enthusiasts just like you to be rock solid at an affordable price. Hyline Offroad would like to thank you for your recent purchase and look forward to serving you in the future.

Hyline Offroad Staff

PLEASE READ INSTRUCTIONS BEFORE BEGINNING INSTALLATION

Front Bumper Installation

Step 1 – Remove plastic factory frame rail cover by unscrewing two plastic screws. Be careful while unscrewing these. The plastic is very weak and is easy to strip out. You will *NOT* be reusing this cover. Also remove the factory plastic air dam, which is located underneath the bumper.

Step 2 – If your vehicle is equipped with factory fog lights you will need to unplug them. Pull out or cut the plastic wire ties that are holding the wires in place (3 Wire Ties) **DO NOT CUT WIRES**. Then, slide stock bumper out far enough to unplug the fog lights.

Step 3 – Remove Stock bumper by unbolting the eight (8) 18mm nuts From backside of bumper. Nuts are located on the inside and outside of frame rails (See Figure 1 - Outside frame rails shown) Say goodbye to that flimsy plastic stock bumper.

Step 4 – If applicable, Unscrew Factory Fog Lights at this point using phillips screw driver. (4 on each light)

Step 5 – Install factory fog lights into Hyline Front Bumper. Make sure the adjustment screw is facing toward the bottom of the bumper. There is a hole in the bumper to allow adjustment after Installation. Assemble fog lights using supplied 8-32 Lock Nuts and Flat Washers. Tighten the nuts with 11/32” Deep Socket or Nut Driver. (See Figure 2)

If Applicable

Disconnect all Aftermarket External Lighting Wiring that is presently attached to existing bumper.

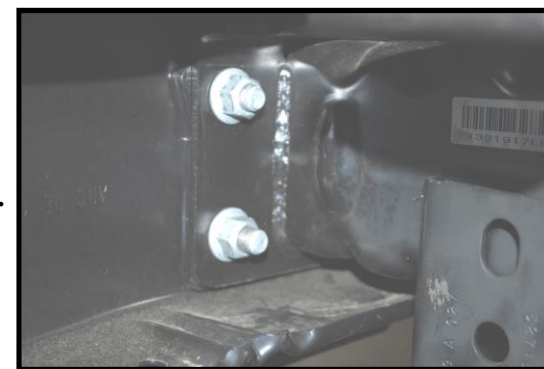

Figure 1

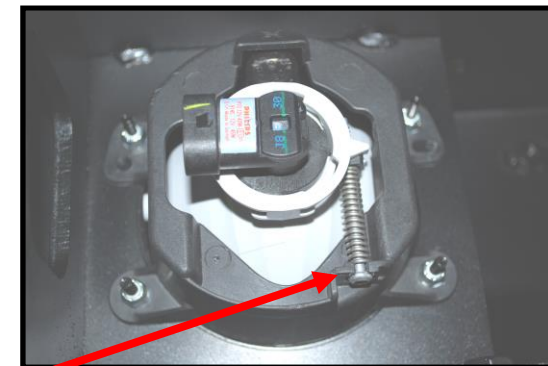

Figure 2

Adjustment Screw

Step 6 – Install Hyline Front Bumper onto vehicle. Two people are recommended for this step. Use supplied 7/16-20 Grade 8 Nuts, Lock Washers and Flat Washers to assemble bumper to frame. (See Figure 3) After all eight nuts are hand threaded you may tighten all nuts to 78 ft/lb torque.

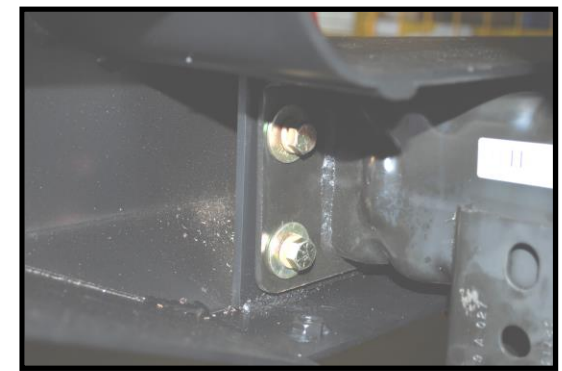

Figure 3

Step 7 – Install Mounting Brackets using supplied 7/16-20 Grade 8 Bolts Lock Washers, Flat Washers, & Nuts. (See Figure 4, 5 & Supplement Diagram 1 on Page 5) These figures are shown with the bumper off the vehicle, however you should have the bumper installed on vehicle prior to assembling brackets. 2012 and newer Jeep models will require you to use the unique bracket with weldnuts on the driver side only in place of the other bracket. Use the 5/8” Wrench on the bolt head and the 11/16” Deep Socket to tighten the nut. It’s going to be a little tight, but is easy once you’re positioned correctly.

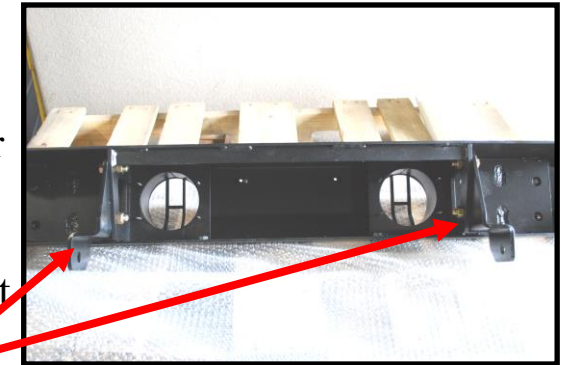
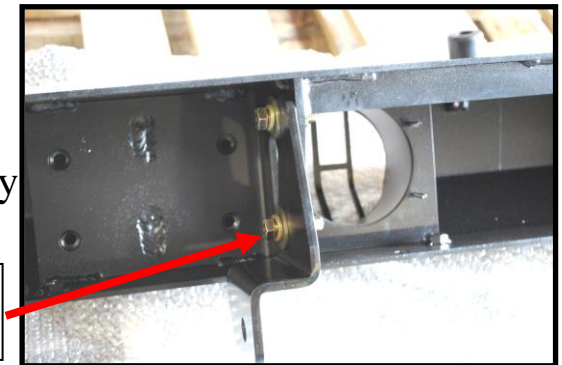

Figure 4

Left & Right Mounting Brackets

Step 8 – Install the last two 7/16-20 Grade 8 bolts on each brackets with Lock Washers & Flat Washers and the Weldnut Tabs. Weldnut Tabs are placed up inside the square tube that is attached vertically to the vehicles’ frame. (See Figure 5)



7/16-20 Bolt is inserted through opposite side of this hole.

Figure 5

Step 9 – Plug in factory fog lights again. Tighten all 7/16-20 Bolts to 78 ft/lb torque and recheck other bolts for tightness.

Optional Winch Installation

Step 1 – Bolt on Fairlead supplied with winch, to the Winch Plate supplied with Bumper. Tighten Bolts.

Step 2 – Mount Winch and Winch Plate onto Bumper using supplied hardware with winch.

Step 3 – Tighten all Winch Bolts to manufacturers torque specifications.

SUPPLEMENT DIAGRAM 1

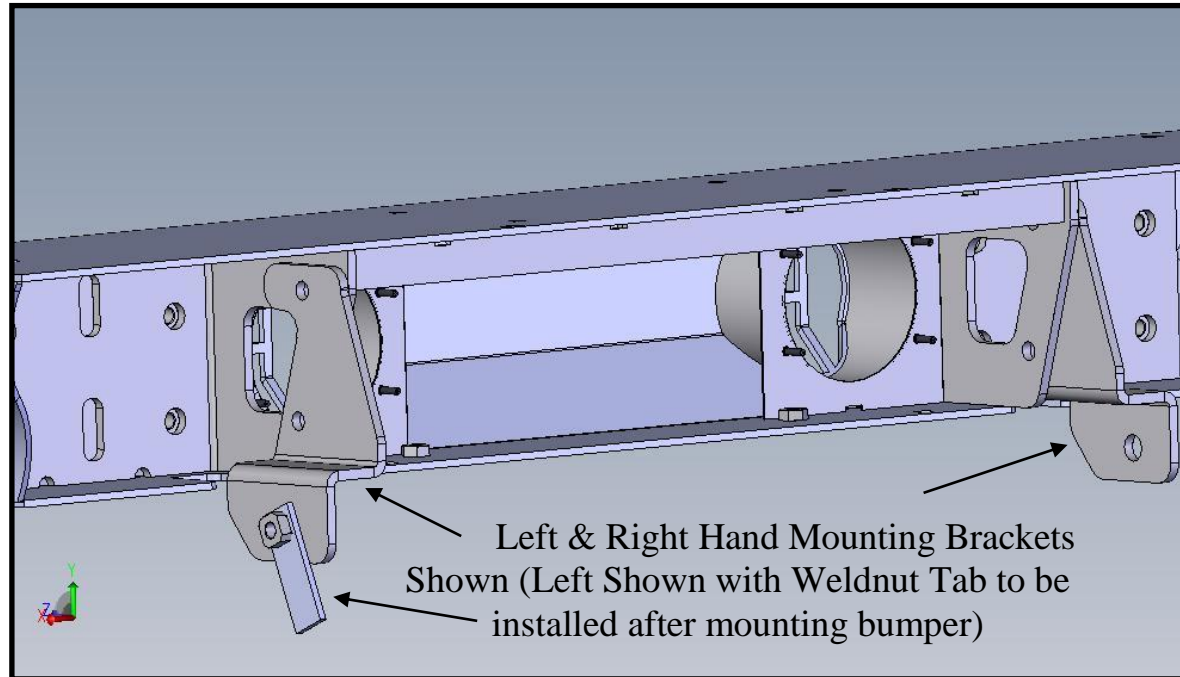

Attention

Installation instructions provided must be read and followed exactly when installing product. Failure to do so could potentially result in injury or death of any occupants in the vehicle. **WEAR SEAT BELTS AT ALL TIMES WHEN DRIVING!**

Though our products are rugged, they are primarily designed and built to enhance the appearance of the vehicle and will not protect from death or injury in the event of an accident. Adhere to all vehicle manufacturers specifications.

Now you're ready for the ROCKS!!

Send your OFFROAD pictures to pics@HylineOffroad.com . If we choose any one of your pictures to be used on our website, We send you a FREE Hyline Offroad T-Shirt.

**** IMPORTANT: PLEASE READ BEFORE INSTALLING**

HYLINE OFFROAD, LLC WARRANTY

HYLINE OFFROAD, LLC. LIMITED WARRANTY Hyline Offroad, LLC, warrants all products against manufacturer's defects in workmanship and material for a period of one (1) year from the date of sale. This warranty applies to manufacturer's defects only and does not cover damage or failure caused by natural causes or third parties.

If product failure does occur within the time period specified according to the provisions of this Warranty, then Hyline Offroad, LLC agrees to provide the replacement product free of charge, F.O.B. factory. This Warranty is valid only so long as the product is installed on the original vehicle. Removal of the product from this vehicle automatically invalidates this Warranty.

As described above, this warranty is expressly limited to the material cost of the product and does not extend to labor costs. Hyline Offroad, LLC will not be responsible for any costs incurred in the removal or reinstallation of the product furnished by manufacturer under this warranty.

CLAIMS PROCEDURE Submit Warranty claim in writing, by certified mail to Hyline Offroad, LLC, 1507 C West Park Avenue, Perkasio, PA 18944. The Claim Notice must state the date of this Notice, the nature of the defect, date of purchase and if already installed, the date of installation, if installed the name of installer and include Proof of Purchase.

This Warranty shall be for the benefit of the original owner only, and is non-transferable. This Warranty is valid in those states where permitted. Some states do not allow limitations on the length of an implied warranty, so the above limitation may not apply to you. Some states do not allow the exclusion or limitation of incidental or consequential damages, so the above limitation or exclusion may not apply to you. You should check your local state laws to determine this. This Warranty gives you specific legal rights, and you may also have other rights, which vary from state to state.

THE WARRANTIES SET FORTH IN THE FOREGOING PROVISIONS ARE LIMITED TO THEIR PRECISE TERMS AND PROVIDE EXCLUSIVE REMEDIES EXPRESSLY IN LIEU OF ALL OTHER WARRANTIES. THERE ARE NO WARRANTIES, EXPRESS OR IMPLIED, WHICH EXTEND BEYOND THE DESCRIPTION IN THE FOREGOING PROVISIONS. HYLINE OFFROAD, LLC EXPRESSLY DISCLAIMS ANY IMPLIED WARRANTY OF MERCHANTABILITY WITH REGARD TO THE PRODUCTS. HYLINE OFFROAD, LLC IS NOT LIABLE TO ANYONE FOR INCIDENTAL OR CONSEQUENTIAL DAMAGES FOR BREACH OF ANY WARRANTY, EXPRESS OR IMPLIED. HYLINE OFFROAD, LLC IS NOT LIABLE FOR DAMAGES TO PERSON OR PROPERTY, CONSEQUENTIAL LOSSES, LOSS OF PROFIT, LOSSES OF PRODUCT IN STORE, OR THE LIKE, UNDER ANY CIRCUMSTANCES AND HYLINE OFFROAD, LLC'S LIABILITY IN ANY CIRCUMSTANCE IS SPECIFICALLY LIMITED BY THE TERMS OF THIS WARRANTY.

HYLINE OFFROAD, LLC HOLD HARMLESS AGREEMENT

1. In purchasing a Hyline Offroad, LLC Product™ I release, waive, discharge and covenant not to sue Hyline Offroad, LLC's officers, servants, agents, or employees (hereinafter referred to as Releasees) from any and all liability, claims, demands, actions and causes of action whatsoever arising out of or related to any loss, damage, or injury, including death, that may be sustained by me (or anyone else), any property belonging to me (or anyone else), whether caused by the negligence of the releasees or otherwise, while working on, using or any activity related to this product.
2. I am fully cognizant of any risks and/or hazards connected with the use of a this product and I elect to willingly engage in such use of this product knowing that the use may be hazardous to me and my property. I willingly assume full responsibility for any risks of loss, property damage or personal injury, including death, that may be sustained by me (or anyone else), or any loss or damage to property owned by me (or anyone else), as a result of using this product, whether caused by the negligence of releasees or otherwise.
3. I further agree to indemnify and hold harmless the releases from any loss, liability, damage or costs, including court cost and attorney fees, that they may incur due to my use of a this product, whether caused by negligence of releasees or otherwise.
4. It is my express intent that this Release and Hold Harmless Agreement shall bind the members of my family and spouse, if I am alive, and my heir's assigns and personal representative, if I am deceased, and shall be deemed as a release, waiver, discharge, and covenant not to sue the above named releasees. I further agree that this Waiver of Liability and Hold Harmless Agreement shall be construed in accordance with the laws of the State of Pennsylvania.

By accepting and installing this product, I acknowledge and represent that I have read the above Warranty and Hold Harmless Agreement, understand it and accept it willingly as my own free act and deed; no oral presentations, statements, or inducements, apart from the foregoing written agreement, have been made; I am at least eighteen (18) years of age and fully competent; and I execute this Release for full, adequate and complete consideration fully intending to be bound by same.

If you do not agree with the preceding Hold Harmless Agreement, you may return the product and receive a full refund. Please, contact a Hyline Offroad sales representative and they will issue a call tag for the product in question. Once the product has been received by Hyline Offroad, inspected and accepted for return, a full refund will be issued.